



Hinged 'T' & 'Y' Fittings

The Schlemmer range of one piece hinged snap-lock fittings make junction creation an easy task when required in applications where a completely sealed harness is not required or for use with PP Split conduit.

The various combinations of outlet diameters allow for the secure attachment of different sized conduit to a main harness and can be used with PA6, PPmod Lockable or PP Split conduit.

Hinged Fittings are also designed to couple together using a 'Hook Up' outlet allowing the user to create custom manifold combinations quickly and easily. Hinged fittings offer protection to a rating of IP54.



Snap-lock clips for quick and easy assembly



Connect multiple fittings together using hookup outlet to create manifolds



Secure grip to conduit



Quick & easy hand assembly - no tools required



Both inside & outside conduit gripping models available



Selected models feature mounting slot compatible with Mounting Clips - page 28 - 29



Compatible with PA6, Lockable or Split conduit *excluding inside gripping



Numerous sizes available. Reducers also available for even more size options - page 24

T-Piece Fittings - Outside Gripping



Part No 9806090

Part No 9806131

Part No 9806121

Y-Piece Fittings - Inside Gripping



Part No 9805540

Y-Piece Fittings - Outside Gripping



Part No 9817083

Part No 9817311

Hinged Fittings Specifications

Material : Polyamide 66 (PA66)
 Operating Temp : -40°C to +135°C

Hinged Fittings

T-Piece - Outside Gripping						
Part No.	NW (A - B - C)	NC (A - B - C)	Hook Up	Mounting Slot	Pack Qty	
9806082	7.5 - 7.5 - 7.5	8 - 8 - 8	-	Yes	1	
9806088	8.5 - 8.5 - 10	10 - 10 - 12	-	Yes	1	
9806097	10 - 10 - 7.5	12 - 12 - 8	-	Yes	1	
9806086	10 - 8.5 - 10	12 - 10 - 12	-	Yes	1	
9806089	10 - 10 - 10	12 - 12 - 12	-	Yes	1	
9806093	13 - 13 - 7.5	16 - 16 - 8	-	Yes	1	
9806090	13 - 8.5 - 10	16 - 10 - 12	-	Yes	1	
9806091	13 - 10 - 10	16 - 12 - 12	-	Yes	1	
9806092	13 - 7.5 - 13	16 - 8 - 16	-	Yes	1	
9806096	17 - 13 - 13	20 - 16 - 16	-	Yes	1	
9806099	17 - 17 - 7.5	20 - 20 - 8	-	Yes	1	
9806095	17 - 7.5 - 17	20 - 8 - 20	-	Yes	1	

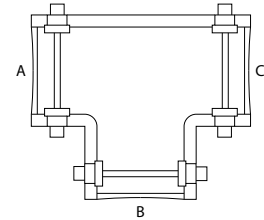

T-Piece - Outside Gripping						
Part No.	NW (A - B - C)	NC (A - B - C)	Hook Up	Mounting Slot	Pack Qty	
9806130	10 - 7.5 - 7.5	12 - 8 - 8	A	No	1	
9806131	13 - 10 - 10	16 - 12 - 12	A	Yes	1	

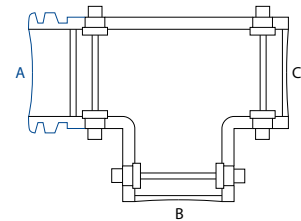

i Create manifold using Hook Up outlet i



Most outside gripping Hinged Fittings feature a single outlet with a protruding ridged ring used to "hook up" with other Hinged Fittings creating manifolds. This ridged ring simulates a piece of corrugated conduit allowing other Hinged Fittings, the next size up, to securely clamp down around it.

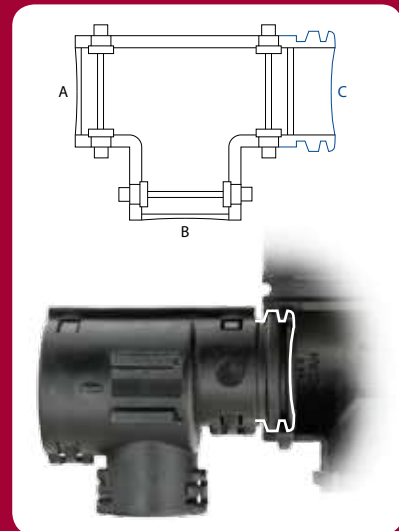

T-Piece - Outside Gripping

Part No.	NW (A - B - C)	NC (A - B - C)	Hook Up	Mounting Slot	Pack Qty
9806133	8.5 - 8.5 - 8.5	10 - 10 - 10	C	Yes	1
9806111	10 - 7.5 - 10	12 - 8 - 12	C	Yes	1
9806160	10 - 10 - 7.5	12 - 12 - 8	C	Yes	1
9806138	10 - 10 - 10	12 - 12 - 12	C	Yes	1
9806127	13 - 4.5 - 10	16 - 6 - 12	C	Yes	1
9806158	13 - 7.5 - 13	16 - 8 - 16	C	Yes	1
9806118	13 - 8.5 - 13	16 - 10 - 16	C	Yes	1
9806172	13 - 10 - 7.5	16 - 12 - 8	C	Yes	1
9806104	13 - 13 - 10	16 - 16 - 12	C	Yes	1
9806159	13 - 13 - 7.5	16 - 16 - 8	C	Yes	1
9806101	13 - 10 - 13	16 - 12 - 16	C	Yes	1
9806115	13 - 13 - 13	16 - 16 - 16	C	Yes	1
9806137	17 - 7.5 - 17	20 - 8 - 20	C	Yes	1
9806120	17 - 8.5 - 17	20 - 10 - 20	C	Yes	1
9806136	17 - 10 - 17	20 - 12 - 20	C	Yes	1
9806107	17 - 10 - 13	20 - 12 - 16	C	Yes	1
9806100	17 - 7.5 - 13	20 - 8 - 16	C	Yes	1
9806166	17 - 13 - 13	20 - 16 - 16	C	Yes	1
9806167	17 - 17 - 7.5	20 - 20 - 8	C	Yes	1
9806141	17 - 13 - 17	20 - 16 - 20	C	Yes	1
9806135	17 - 22 - 17	20 - 25 - 20	C	Yes	1
9806149	22 - 8.5 - 22	25 - 10 - 25	C	No	1
9806143	22 - 10 - 10	25 - 12 - 12	C	No	1
9806178	22 - 22 - 10	25 - 25 - 12	C	No	1
9806103	22 - 17 - 13	25 - 20 - 16	C	Yes	1
9806142	22 - 22 - 13	25 - 25 - 16	C	No	1
9806126	22 - 22 - 17	25 - 25 - 20	C	No	1
9806114	22 - 13 - 17	25 - 16 - 20	C	No	1
9806113	22 - 7.5 - 22	25 - 8 - 25	C	No	1
9806121	22 - 10 - 22	25 - 12 - 25	C	No	1
9806108	22 - 13 - 22	25 - 16 - 25	C	No	1
9806102	22 - 22 - 22	25 - 25 - 25	C	No	1
9806124	26 - 17 - 13	30 - 20 - 16	C	No	1
9806112	26 - 22 - 22	30 - 25 - 25	C	No	1
9806110	26 - 26 - 22	30 - 30 - 25	C	No	1
9806129	26 - 10 - 26	30 - 12 - 30	C	No	1
9806146	26 - 17 - 26	30 - 20 - 30	C	No	1

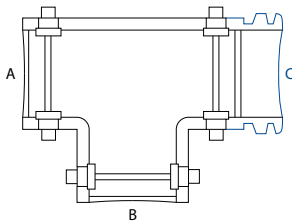

Hinged Fittings

Y-Piece - Outside Gripping

Part No.	NW (A - B - C)	NC (A - B - C)	Hook Up	Mounting Slot	Pack Qty	Fig
9817083	7.5 - 4.5 - 7.5	8 - 6 - 8	-	No	1	1
9817079	7.5 - 7.5 - 7.5	8 - 8 - 8	-	No	1	1
9817303	10 - 10 - 10	12 - 12 - 12	A	No	1	4
9817304	13 - 7.5 - 10	16 - 8 - 12	C	Yes	1	3
9817306	13 - 10 - 10	16 - 12 - 12	C	No	1	3
9817305	13 - 10 - 13	16 - 12 - 16	C	No	1	3
9817308	13 - 13 - 13	16 - 16 - 16	C	No	1	3
SM200812	17 - 7.5* - 10	20 - 8* - 12	C	No	1	3
SM201212	17 - 10* - 10	20 - 12* - 12	C	No	1	3
9817310	17 - 13 - 10	20 - 16 - 12	C	No	1	3
9817309	17 - 17 - 10	20 - 20 - 12	C	No	1	3
9817201	17 - 13 - 17	20 - 16 - 20	A	No	1	2
9817200	22 - 10 - 17	25 - 12 - 20	A	No	1	2
9817203	22 - 13 - 17	25 - 16 - 20	A	No	1	2
9817202	22 - 17 - 17	25 - 20 - 20	A	No	1	2
SM251225	22 - 10* - 22	25 - 12* - 25	C	No	1	3
9817311	22 - 13 - 22	25 - 16 - 25	C	No	1	3
9817302	22 - 22 - 22	25 - 25 - 25	C	No	1	3

* Reducer supplied to achieve outlet size.

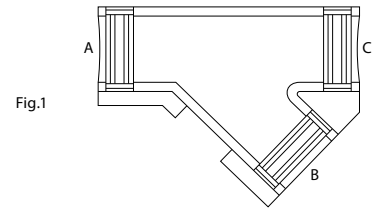

Fig.1

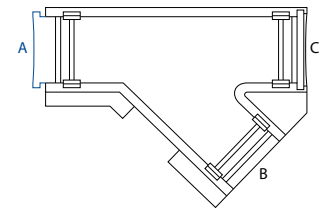

Fig.2

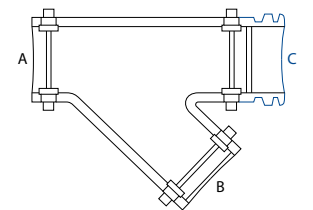

Fig.3

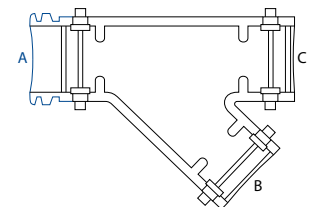
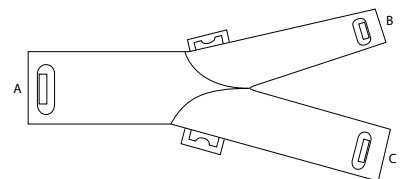

Fig.4

Y-Piece - Inside Gripping

Part No.	NW (A - B - C)	NC (A - B - C)	Pack Qty
9817085	8.5 - 8.5 - 8.5	10 - 10 - 10	1
9817107	10 - 8.5 - 8.5	12 - 10 - 10	1
9805524	10 - 10 - 10	12 - 12 - 12	1
9805575	13 - 10 - 10	16 - 12 - 12	1
9805583	13 - 13 - 10	16 - 16 - 12	1
9805559	17 - 10 - 10	20 - 12 - 12	1
9805567	17 - 13 - 10	20 - 16 - 12	1
9805540	17 - 13 - 13	20 - 16 - 16	1
9806059	17 - 17 - 10	20 - 20 - 12	1

Inside gripping Y-Piece fittings are only compatible with PA6 corrugated conduit.





Reducers for Hinged Fittings

Used in conjunction with either 'T' or 'Y' piece fittings these reducers can either enable a conduit outlet to accept smaller size conduit or allow multiple smaller conduits to exit a single outlet.



Easily reduce manifold outlet size to suit application



Compatible with both T and Y piece manifolds



Convert 'T' Piece outlet to a 2 or 3 conduit outlet

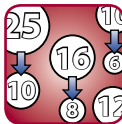

Multiple size conversions available



Fig. 1



Fig. 2



Fig. 3



Fig. 4

Reducers Specifications

Material : Polyamide 66 (PA66)
 Operating Temp : -40°C to +135°C

Reducers for use with Hinged Fittings

Part No.	NW Size Reduction	NC Size Reduction	Pack Qty	Fig
7807270	8.5 to 4.5	10 to 6	10	1
7807272	10 to 4.5	12 to 6	10	1
7807276	10 to 7.5	12 to 8	10	1
7807288	10 to 8.5	12 to 10	10	2
7807278	13 to 7.5	16 to 8	10	1
7807280	13 to 10	16 to 12	10	1
7807296	17 to 13	20 to 16	10	2
7807294	22 to 13	25 to 16	10	2
7807282	22 to 17	25 to 20	10	1
7807290	22 to 7.5 - 7.5	25 to 8 - 8	10	3
7807291	22 to 8.5 - 7.5	25 to 10 - 8	10	3
7807292	22 to 7.5 - 7.5 - 7.5	25 to 8 - 8 - 8	10	4
7807295	29 to 8.5 - 8.5 - 8.5	32 to 10 - 10 - 10	10	4

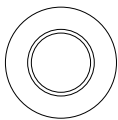

Fig.1

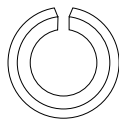

Fig.2

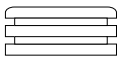

Fig.3



Fig.4